

Varenummer: 0118033  
 Beskrivelse: Seeger låsering H 17

## Mål

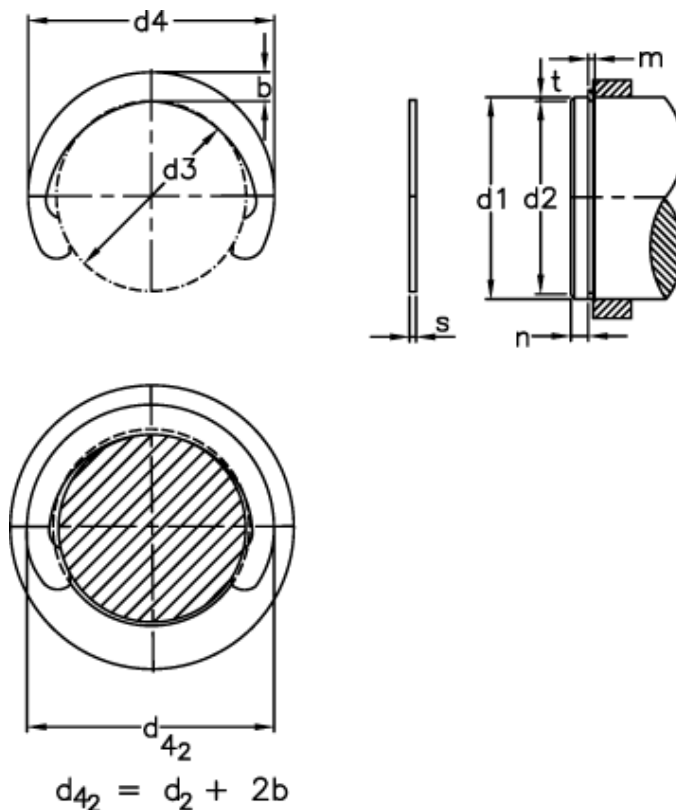

b	= 2.25	FRg kN	= 2.0	t	= 0.80
Betegnelse	= H 17,0	FR kN	= 6.00	tol	= -0.11
d1	= 17	g	= 1.00	tol	= 0.18
d2	= 15.4	Griber	= GRH 17	tol	= -0.06
d3	= 14.90	m min	= 1.10	vægt kg/1000	= 0.64
d4	= 19.40	n abl x 1000	= 23		
d4 2	= 19.9	Nominel træk	= 2.4		
FN kN	= 3.40	s	= 1.00		